



TRU-WELD

Stud Welding



TW6922

Heavy-Duty Stud Welding System

Operations Manual

Table of Contents

Description	Page
Warranty Information	1
Company Profile and Product Information	2
Safety Precautions - Symbols and Fumes	3
Safety Precautions - Electric Shock and Arc Rays	4
Safety Precautions - Welding Sparks and EMF's	5
TW6922 Product Specifications	6
TW6922 Setup and Installation - Initial Steps	7
TW6922 Setup and Installation - Power Diagrams	8
TW6922 Setup and Installation - Primary Power	9
Stud Gun Setup - Initial Steps	10
Stud Gun Setup - Lift Adjustment	11
Stud Gun Setup - Free Travel Adjustment and Weld Preparation	12
Cable Connection - Ground Cable Connections	13
Cable Connection - Weld Cable Connections	14
Machine Operation - Powering On and Control Panel	15
Machine Operation - Menu Selection	16
Machine Operation - Time and Current Settings	17
Machine Operation - Preset Menu	18
Machine Operation - Stud Counters	19
Suggested Time and Current Settings	20
Welding - Step by Step Process	21
Welding Hints and Suggestions	22
Weld Inspection - Visual Inspection	23
TW6922 Troubleshooting	24
TW6922 Troubleshooting	25
TW6922 Troubleshooting	26
Parts and Accessories	27

Warranty Information

TRU-WELD EQUIPMENT LIMITED WARRANTY

All goods produced by TRU-WELD shall be warranted against defects including workmanship and components. No other warranties whether expressed, verbal, or implied will apply. Warranties only apply to the original equipment purchaser.

Warranty claims will be limited to either repair or replacement of the defective materials by TRU-WELD. At the option of TRU-WELD the location of where the warranty evaluation and repairs are made will be determined. All warranty claim items returned to TRU-WELD will be at the customer's expense. At the option of TRU-WELD the defect will either be repaired or replaced. Notice must be provided to TRU-WELD of a warranty defect within 30 days that the defect or failure is incurred. Warranties are not transferable.

This warranty does not apply for equipment which is used improperly in any fashion including but not exclusive to the following:

- Equipment which has been modified
- Equipment which has not been installed properly
- Equipment which has been used for purposes other than which it had been designed
- Equipment which has not been properly maintained
- Equipment which was continued to be used after a defect had been found
- Equipment which was damaged in any way

Truweld Equipment will never be liable for consequential damages, loss, or expense occurring directly or indirectly from the use of the equipment covered in this warranty.

All cables, cable sets and connectors are not covered under warranty

Two (2) year warranty period from date of purchase

- | | | | |
|--------------------------|-----------------------|-----------------------|-----------------------|
| • TWE250 Power Supply | • SC900 Power Supply | • SC2400 Power Supply | • TW5500 Power Supply |
| • TWE250CP Power Supply | • SC950 Power Supply | • SC2402 Power Supply | • TW5600 Power Supply |
| • TWE321 Power Supply | • SC1400Power Supply | • SC2420 Power Supply | • TW5700 Power Supply |
| • TWE375 Power Supply | • SC1450 Power Supply | • SC3400 Power Supply | • TW6800 Power Supply |
| • TW-i250 Power Supply | • SC1600 Power Supply | • SC3402 Power Supply | • TW6802 Power Supply |
| • TW-i250CP Power Supply | • SC1650 Power Supply | • SC3422 Power Supply | • TW6900 Power Supply |
| • TW-i321 Power Supply | • SC1900 Power Supply | • TW4300 Power Supply | • TW6902 Power Supply |
| • TW-i375 Power Supply | • SC1950 Power Supply | • TW4400 Power Supply | • TW6950 Power Supply |

One (1) year warranty period from date of purchase

- | | | |
|-----------------------|----------------------|-------------------------|
| • TWESPC Power Supply | • TWP-2 Power Supply | • ACE-P100 Power Supply |
|-----------------------|----------------------|-------------------------|

Ninety (90) day warranty period from date of purchase

- | | |
|----------------------|----------------------------|
| • TWEGP CD stud gun | • TWE17000 HD arc stud gun |
| • TWEG CD stud gun | • TWE18500 MD arc stud gun |
| • TWEHDG CD stud gun | • TWE19000 LD arc stud gun |

Company and Product Information

Company Profile

TRU-WELD Stud Welding has been manufacturing weld studs since 1959 and high-quality stud welding equipment since 1970. TRU-WELD is located in Medina, Ohio and has product and equipment distributors throughout the United States and Canada.

Our Mission

Our experienced Management and Staff is committed to provide the utmost in quality and service in every step of our production, while remaining competitive in the marketplace. It is our goal to meet our customer's needs more effectively than our competitors through a process of continuous quality improvement. Our long-standing relationship with our customers' and suppliers' is our key to continued success and growth. If we can be of any further assistance to you and your company, please do not hesitate to contact us.

Product Information

The TW6922 is a fully integrated 3000A two-wire dual-gun stud welding system with two digital controls for time and current. The system is designed to meet the most challenging stud welding jobs including weld thru-deck applications (also includes G90 decking).

Features:

- ◆ Enhanced duty cycle for production requirements and powerful output for even the largest diameter jobs
- ◆ Factory presets and user customizable presets
- ◆ Improved weld control
- ◆ **PRO-TECH'D** technology protects the gun circuitry

Complete system Includes:

- ◆ (1) TWE6922 power supply
- ◆ (2) TWE17000N HD two-wire stud gun
- ◆ (2) 50' of 4/0 weld and control cable
- ◆ (2) 25' of 4/0 ground cable assembly

Stud Welding Safety Precautions

Do not install, operate, or repair this equipment without carefully reading the manual and observing all of the safety precautions mentioned.

Safety Symbols

Every effort has been made to protect trained operators from injury or unnecessary risk. Certain symbols are used throughout this manual to call attention to safety-related information and instruction. The safety symbols in this manual have these meanings:



This symbol indicates dangerous situations. When this symbol is used within this manual, death or serious bodily harm is possible or probable if the corresponding preventative measures are not taken. Operators must take caution in the method and manner of handling or using the machine when this symbol is displayed.

Safety Precautions

Do not install, operate, or repair the TW6922 welding equipment without reading this manual and all safety precautions stated within!

The TW6922 was designed and built with operator safety in mind. Every effort has been made to protect the trained operator from injury. Familiarization with the information in this manual is to minimize the risk of shock or injury.



STUD WELDING CAN BE HAZARDOUS. ALWAYS PROTECT YOURSELF AND OTHERS FROM POSSIBLE INJURY OR DEATH. KEEP CHILDREN AWAY.

Operators who have a pacemaker should consult with their physician before operating stud welding equipment.

FUMES and OXYGEN DEPLETION

- ◆ Only weld in areas where adequate ventilation of weld gases is possible and where there is no fire, smoke, or explosion hazards
- ◆ When working in a confined space always have trained support personnel nearby
- ◆ Welding fumes and gases can displace air and lower the oxygen level causing injury or death, be sure the breathing air is safe
- ◆ Do not weld in locations near degreasing, cleaning, or spraying operations, the heat and rays of the arc can react with vapors resulting in highly toxic or irritating gases
- ◆ Do not weld on coated metals, such as galvanized, lead, or cadmium plated steel, coatings and metals containing these elements can generate toxic fumes when heated to welding temperature



Stud Welding Safety Precautions

ELECTRIC SHOCK



Electric shock can injure or kill!

Precautionary measures must be taken to provide maximum protection against electrical shock

- ◆ Do not touch live or energized electrical parts or store metallic objects near power
 - ◆ Ground the work or metal to be welded to a good electrical (earth) ground
 - ◆ Do not leave an energized machine unattended
 - ◆ Never work in wet clothing, gloves or footwear
 - ◆ Insulate yourself from work and ground using dry insulation, make certain the insulation is large enough to cover your full area of physical contact with work and ground
 - ◆ Inspect all system components, protective equipment, cables, connectors and gas lines prior to operating equipment, never use cables that are longer than necessary
 - ◆ When testing a live unit, use the one-hand method, do not put both hands inside of the unit, keep one hand free
 - ◆ Disconnect input power conductors from de-energized supply line before moving a welding power source
 - ◆ Always be sure the work cable makes a good electrical connection with the metal being welded, the connection should be as close as possible to the area being welded
 - ◆ Turn OFF welding power source before servicing unless the procedure specifically requires an energized unit
-  ◆ Never touch the energized stud or gun before discharging the stud to ground
-  ◆ Never use the power source to provide heat for thawing frozen pipes

ARC RAYS and EYE PROTECTION



**Arc rays can injure eyes and burn skin.
Arc flashes are painful.**

- ◆ Use a shield with the proper filter and cover plates to protect eyes from sparks and the rays of the arc when welding or while observing open arc welding
- ◆ Use protective clothing specifically intended for work with welding equipment, it should be made of durable flame-resistant material to provide ample protection from the arc rays
- ◆ Protect other nearby workers with suitable, non-flammable screening
- ◆ Caution other workers not to watch the arc nor expose themselves to the arc rays or to hot spatter or metal

Stud Welding Safety Precautions

WELDING SPARKS



Heat from flames and arcs can start fires. Hot slag or sparks can also cause fires and explosions.

Remove all combustible materials from the work area or cover these materials with a protective non-flammable tarp. Combustible materials include wood, fabrics, sawdust, liquid and gas fuels, solvents, paints and coatings, paper, etc.

Hot sparks or hot metal can fall through cracks or crevices in floors or wall openings and cause a hidden smoldering fire. Make certain that such openings are protected from hot sparks and metal.

ELECTRIC and MAGNETIC FIELDS

Electric current flowing through any conductor causes localized Electro-Magnetic Fields (EMF). Welding and cutting current creates EMF around welding cables and welding machines.

- ◆ Operators having pacemakers should consult their physician before welding, EMF may interfere with some pacemakers
- ◆ Exposure to EMF may have other health effects, which are unknown
- ◆ Operators should use the following procedures to minimize exposure to EMF
- ◆ Route the work cables together, secure them with electrical tape when possible
- ◆ Never coil the work cable around any part of the body
- ◆ Do not stand between the work cables
- ◆ Connect the work cable to the work piece as close as possible to the area being welded
- ◆ Keep welding power source and cables as far away from your body as possible
- ◆ Electromagnetic fields can irrevocably erase magnetic data carriers (computer memory, credit cards, security ID cards, etc.)
- ◆ Electromagnetic fields may magnetize and damage watches or similar digital devices

PROTECT YOURSELF and OTHERS



Some welding, cutting, and gouging processes are noisy and require ear protection. The arc, like the sun, emits ultraviolet (UV) and other radiation and may injure skin and eyes. Hot metal can cause burns. Training in the proper use of welding processes and equipment is essential to prevent accidents.

- ◆ Wear flameproof type gloves, heavy long-sleeve shirt, cuffless trousers, and a welding helmet or cap for hair protection, to protect against arc rays and hot sparks or hot metal. A flameproof apron may also be desirable as protection against radiated heat and sparks.
- ◆ Hot sparks or metal can lodge in rolled up sleeves, trouser cuffs, or pockets. Sleeves and collars should be kept buttoned, and open pockets eliminated from the front of clothing.

TW6922 Product Specifications

Weld Range	1/4" to 1-1/4"	Consistent welding regardless of stud diameter.
Duty Cycle	1/4" thru 5/8" 3/4" 7/8" 1" 1-1/4"	Unlimited 22 to 24 per minute 16 to 18 per minute 12 to 14 per minute 4 to 5 per minute
Dimensions	Height Width Length Weight	28" (736.6mm) 29" (711.2mm) 36" (914.4mm) 876 Lbs. (398kg)
Input Voltages		230 / 460 / 575 VAC 3 Phase 60Hz (400 VAC 3 Phase 50Hz option available)
Fusing Requirements (slow acting)		230 / 200 Amps 400 / 100 Amps 460 / 100 Amps 575 / 90 Amps

** Specifications are subject to change without prior notification

TW6922 Setup and Installation

Initial Steps



Only qualified personnel should perform this installation.

This section provides detailed instructions for the proper installation of the TW6922. It is recommended that these instructions be followed carefully to allow for the best possible operating environment.

Handling and Unpacking the Welder

Immediately upon receipt of the welder, inspect the shipment for any damage and notify the carrier of such damage before accepting delivery. Inspect welder for damage which may have occurred in transit. After removing the components from the shipping container(s), check the container for any loose parts. Remove all packing materials. Visually check all air passages of power source for any packing materials that may obstruct airflow through the welder. If the equipment is not being installed immediately, store it in a clean, dry, well-ventilated area until installation.

Selecting a Location

The location of the power source should be carefully selected to ensure satisfactory and dependable service. Choose a location relatively close to a properly fused source of electrical power. Use care against toppling over if the machine is placed on a tilted surface or plane. It is important that the machine be located in an open area where air can circulate freely through the front and rear openings. If space is at a premium, leave at least 1 foot (300 mm) of clearance between the rear of the power source and wall or other obstruction.

Electrical Input Requirement

The welding power source is designed to be operated from three-phase, 60Hertz, AC power supply. Consult the local electrical utility supplier if there are any questions on the electrical system at the present installation site. The TW6922 should be operated from a separate, fused or circuit-breaker protected circuit.

TW6922 Setup and Installation

Power Connection Diagrams

Electrical Input Requirements

The TW6922 is equipped with an input voltage jumper block so the unit can be operated with different line voltages depending on the supplied voltage. The jumper setting should be checked to see if they are properly positioned for the voltage being used.

- ◆ Remove the TW6922 top cover
- ◆ Cross the terminals on the jumper block with the jumper and tighten the hold down nuts
- ◆ Use the schematic below for the jumper setting to suit the line voltage requirements

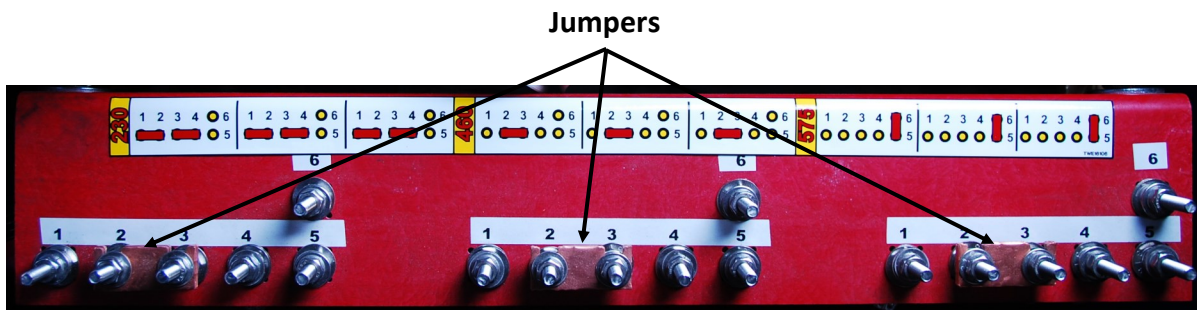

230VAC

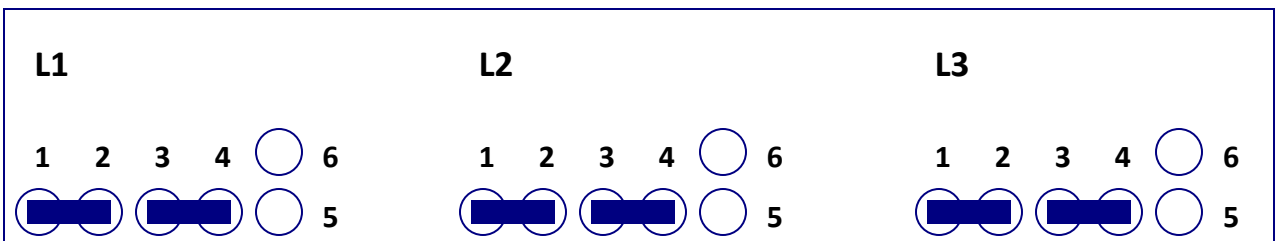

460VAC

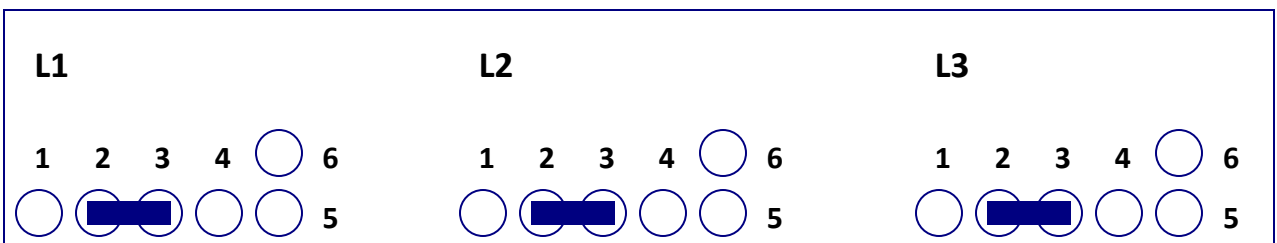

575VAC

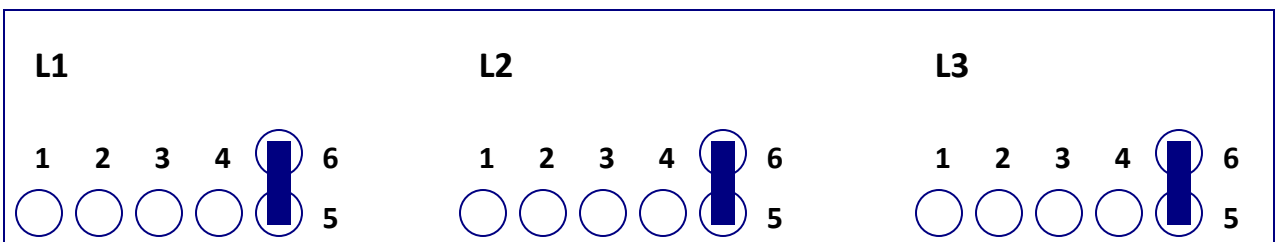

TW6922 Setup and Installation

Preparing the Unit for Primary Power



Only qualified personnel should perform this installation.

- ◆ Turn the input power off at the disconnect switch or fuse box before working on the welder
- ◆ Do not touch electrically hot parts

Primary Power Cable and Ground Connection

- ◆ Remove the top cover of the TW6922
- ◆ Route the primary power cable through the power inlet hole in the top left corner on the backside of the welder with enough slack to reach the terminal block
- ◆ Connect the ground wire to the frame of the welder as shown below
- ◆ Connect the power leads (black, white, red) to the L1, L2, and L3 connectors on the terminal block, as shown below

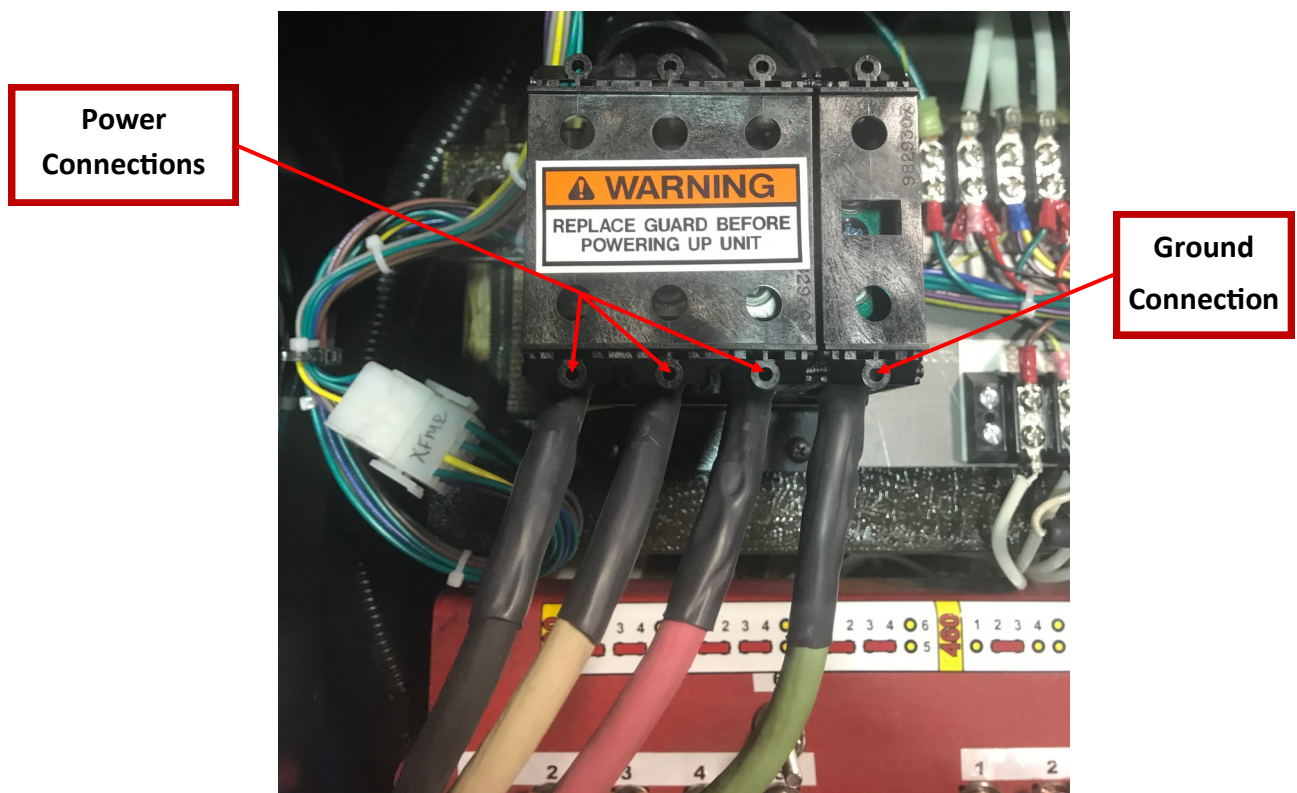

Stud Gun Setup

TWE17000N Gun Setup

Each stud welding application requires that the stud gun be set up properly for the correct stud and ferrule arrangement.

- ◆ Select the correct style and size of chuck and attach it to the stud gun
- ◆ Select the appropriate length leg assembly, foot piece, and ferrule grip
- ◆ Secure ferrule grip to the foot piece
- ◆ Tighten leg screws and washers to the foot piece and slide the legs through the front cap nuts

After the accessories have been mounted to the stud gun place a stud into the chuck and begin the alignment of the accessories.

- ◆ Fully seat a stud into the chuck so that the stud is held firmly
- ◆ Insert a ferrule into the ferrule grip
- ◆ Move the leg, foot and ferrule assembly so that the stud protrudes beyond the ferrule
 - ◆ 1/8" stick out for studs 1/2" and smaller in diameter
 - ◆ 3/16" stick out for studs 5/8" through 7/8" in diameter
 - ◆ 1/4" stick out for studs 1" to 1-1/4" in diameter
- ◆ Position the ferrule grip assembly so that the stud moves freely through the ferrule when lift is simulated

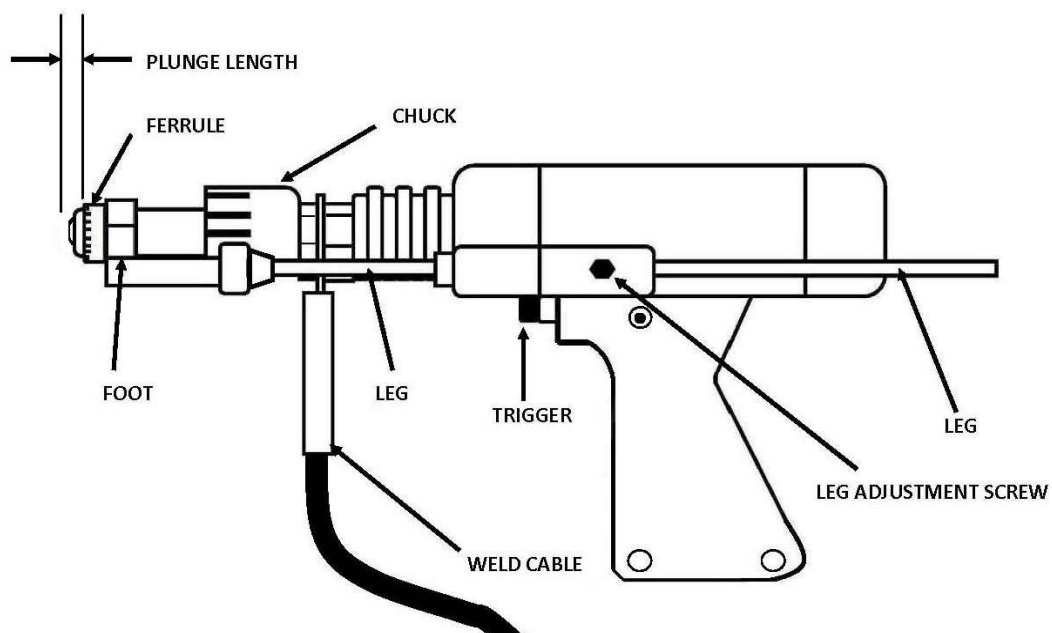

Stud Gun Setup

Lift

Set the lift when all of the accessories and stud have been properly set on the stud gun and prior to welding. Plug the stud gun control connector directly into the stud welder (do not attach the weld cable). Turn on the stud welder and actuate the trigger of the stud gun with the stud and ferrule in place. Note the retraction of the shaft of the stud gun, this is designated as the lift.

The lift setting should be approximately 3/32" for general welding applications and studs ranging up to 3/4" in diameter. Larger diameter studs and select applications should have an 1/8" lift setting.

Adjusting the lift:

- ◆ Remove the back cap of the stud gun
- ◆ Loosen the two socket set screws around the periphery of the lift adjustment screw
- ◆ To increase lift rotate the lift adjustment screw counter clockwise and to decrease lift rotate clockwise
- ◆ With each turn check the lift by actuating the stud gun until the desired lift is achieved
- ◆ Tighten the socket set screws to hold the lift adjustment screw in place to secure the selected setting
- ◆ Replace the back cap of the stud gun

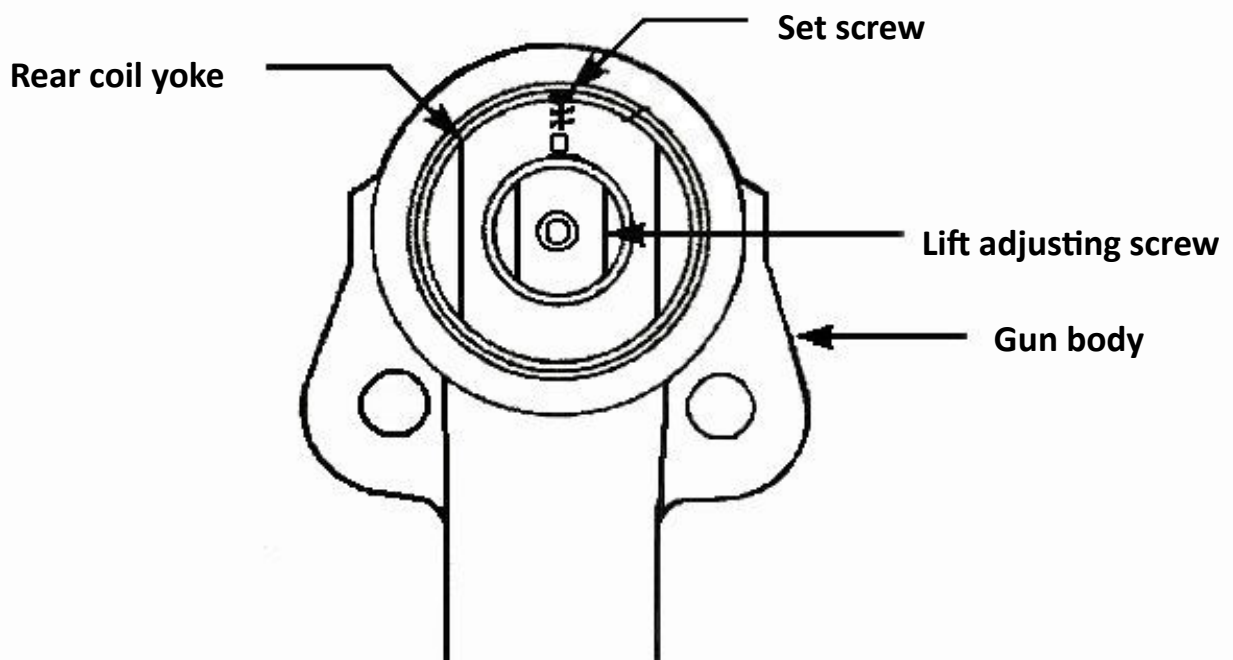

Stud Gun Setup

Free Travel Adjustment

This adjustment can be used to control the force with which the stud is plunged into the molten weld pool by moving the engagement point of when the shaft of the stud gun engages the dampener. Rotating the dampener cover counter clockwise increases the amount of free travel.

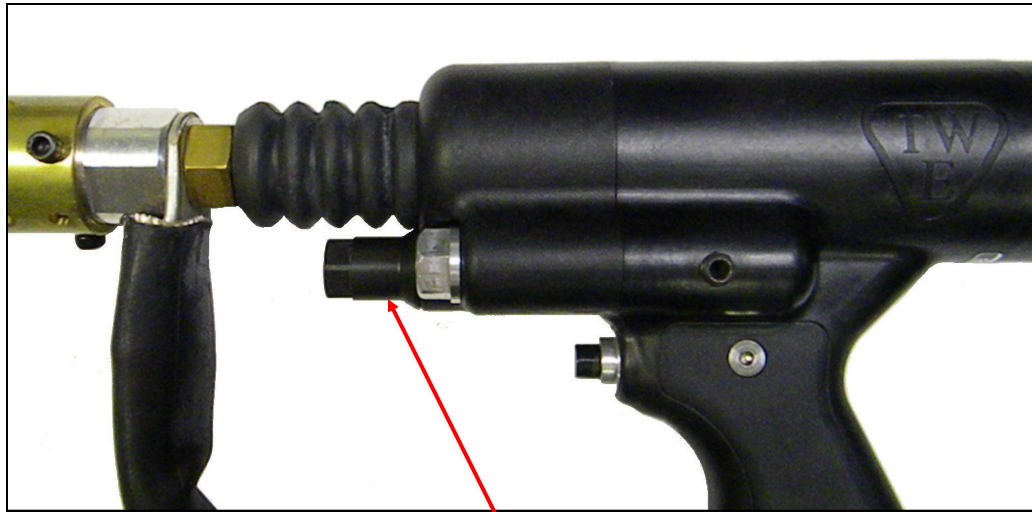

Dampener cover

Attaching the stud gun to start welding

- ◆ Select the gun, control cable, and weld cable that is recommended for the specific type of welder and job
- ◆ Attach stud gun to weld and control cable extension
- ◆ Actuate the stud gun without placing it on the surface to be welded to assure that the connection through the control cable is correct to complete the circuit
- ◆ Confirm time and current settings are correct
- ◆ Place the selected stud into the chuck and attach the ferrule to the ferrule grip
- ◆ Place stud onto surface to be welded and press stud gun down until ferrule is flush with the welding surface
- ◆ Trigger the gun and hold in place until cycle is completed
- ◆ Pull gun assembly straight up off of the welded stud
- ◆ Do not depress trigger when removing gun from stud
- ◆ Remove the ferrule by breaking it off and inspect the weld
- ◆ Make proper adjustments if needed

TW6922 Cable Connection

Ground Cable Connections

- ◆ The TW6922 is equipped with two ground cable connections located beneath the access panel on the front of the machine
- ◆ Tighten the ground cable to the bracket and secure the heavy duty C-clamp to the work surface

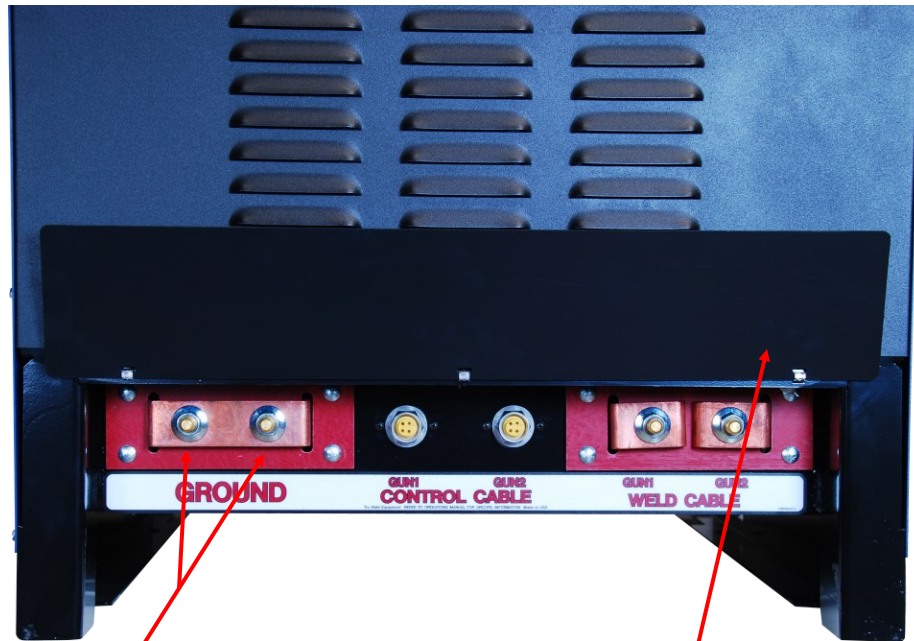

Ground connections

Access panel

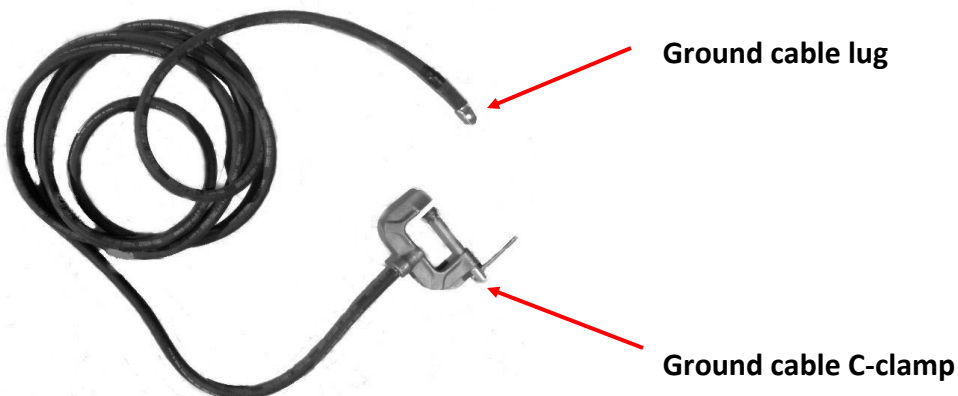

Ground cable lug

Ground cable C-clamp

TW6922 Cable Connection

Weld Cable Connections

- ◆ The TW6922 has two weld and control cable connections on the front of the welder behind the access panel
- ◆ Tighten the weld cable lug to the weld cable bracket labeled Gun 1
- ◆ Plug the male control cable connector to the female panel mount labeled Gun 1
- ◆ Repeat these steps for the Gun 2 connections

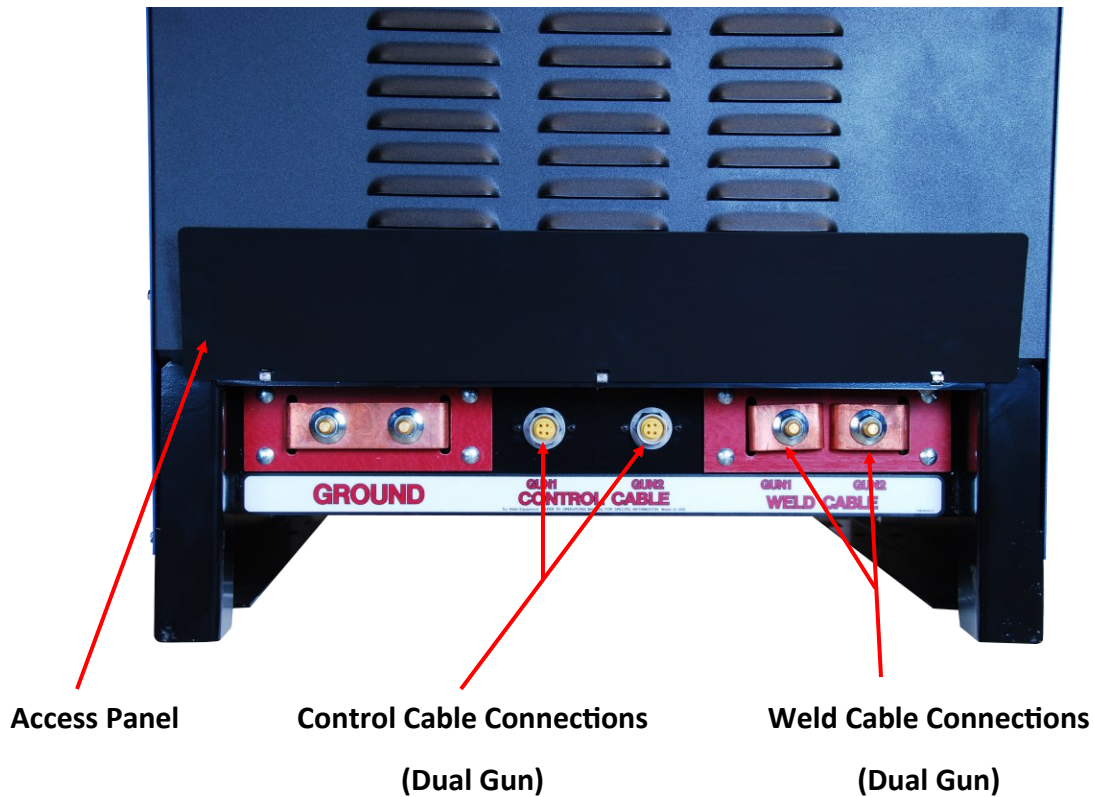

TW6922 Operation

TW6922 Power Switch/Power On

The power switch for the TW6922 is located on the right front of the welder's control panel. Off position is vertical with the "O" showing. On position is horizontal with the "I" displayed.

When the welder is turned on, the digital display will go through a self-diagnostic check. This takes approximately 3 to 5 seconds, and then the digital display will show the last time and current setting. Once the time and current is displayed, the unit is ready to weld. When connected to the welder, the stud gun will actuate 3 times, indicating that there is a good connection.



TW6922 Control Panel

Brightness Switch — LED brightness can be set to indoor or outdoor brightness levels

Time Button — Used to adjust time settings

Current Button — Used to adjust current settings

Digital Display — Displays weld settings, machine presets, or weld counters

Diagnostic LED — Used to determine an issue with weld/control cable or machine

Fine/Coarse Switch — Can be selected to adjust time or current by 10th's or 100th's

Menu Options — Shows which menu the machine is displaying

Adjustment Dial — Used to toggle through menus or adjust the time and current

Supervisor Lock — Locks the machine so changes cannot be made to the weld settings

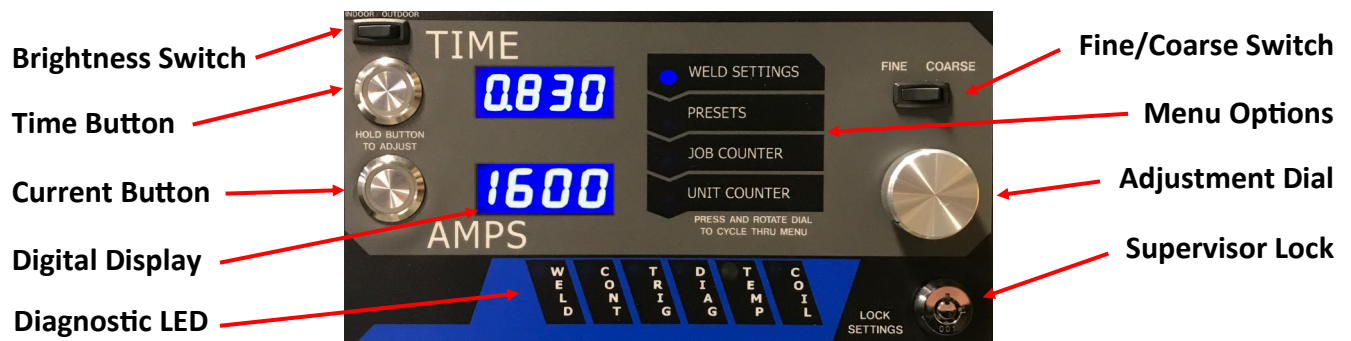

TW6922 Operation

Menu Selection

By depressing the adjustment dial and rotating clockwise or counter clockwise a menu can be chosen. The menus include weld settings, welding presets, job counter, and a lifetime unit counter.



Menu Selection:

1. Verify supervisor lock is off
2. To chose a menu, depress and hold down the adjustment dial
3. Turn adjustment dial clockwise or counter-clockwise to cycle through the different menu options
4. Stop rotating the dial when the LED for the desired menu is illuminated
5. Release the adjustment dial

TW6922 Operation

Weld Settings - Time and Current

The time and current controls are located on the front of the welder. The controls consist of a time button, current button, adjustment dial, fine/coarse switch, and a supervisor lock. The digital display will indicate the settings chosen during setup.

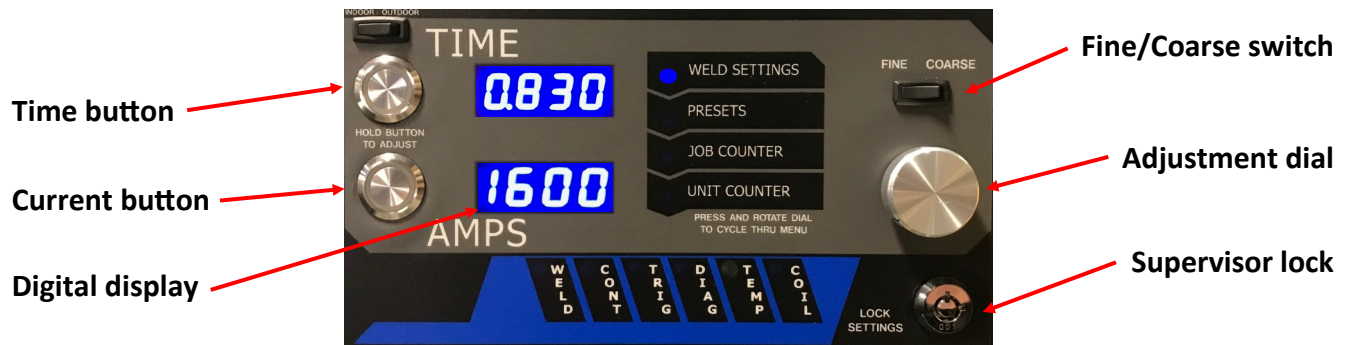

Adjusting the Time Setting:

1. Verify the supervisor lock is off
2. Set the FINE/COARSE switch to the desired position
3. Press and hold the TIME button
4. Turn the dial to adjust the setting
5. Release the TIME button

Adjusting the Current Setting:

1. Verify the supervisor lock is off
2. Set the FINE/COARSE switch to the desired position
3. Press and hold the AMPS button
4. Turn the dial to adjust the setting
5. Release the AMPS button

TW6922 Operation

Preset Menu

The full range of studs the machine is capable of welding is preloaded onto the unit for fast and easy access. Any combination of time and current can also be saved to a programmable preset location.

Selecting Custom Presets:

1. Navigate to the Preset Menu
2. Rotate the dial counter-clockwise to the desired preset
3. Press and release dial

Saving Custom Presets:

1. Set the weld settings to the settings to be saved
2. Navigate to the Preset Menu
3. Navigate to the desired custom preset
4. Press and hold the dial in until the menu switches back to the Weld Settings Menu

Selecting a Factory Preset:

1. Navigate to the Preset Menu
2. Rotate the dial clockwise to the desired stud diameter
3. Press and release the dial

Exiting back to the Weld Settings Menu (all available options):

1. Navigate to the Weld Settings Menu using the dial method listed previously
2. Turn the dial to the end of the custom preset options, press and release the dial
3. Turn the dial to the end of the factory preset options, press and release the dial
4. Press and release the AMPS or TIME adjustment buttons

TW6922 Operation

Weld Counter and Weld Counter Reset

The TW6922 is equipped with two different counters to display the number of times the unit has drawn an arc.

Job Counter (Resettable) - Is a running total of the number of welds since the counter was last reset. This counter can easily be reset from the job counter menu.

Unit Weld Counter (Non-resettable) - Is a running total of every time an arc is drawn on the machine. This is programmed from the factory and can not be reset.

Resetting The Job Counter:

1. Navigate to the Job Counter Menu
2. Press and hold the dial in until the counter changes to 0

Viewing Unit Counter:

1. Navigate to the Unit Counter Menu

Exiting Unit/Job Counter: - To exit the counter menu navigate to the weld settings menu using the dial method or press and release the AMPS or TIME adjustment buttons.



Job counter will display here

TW6922 Suggested Weld Settings

Suggested Settings (Full Base Diameter Studs)

DIA INCH	TIME SEC	AMPS DC	DIA DEC	DIA MM
1/4	0.200	500	.250	6.35
5/16	0.300	550	.312	7.93
3/8	0.350	600	.375	9.52
7/16	0.420	700	.437	11.11
1/2	0.500	900	.500	12.70
5/8	0.670	1200	.625	15.87
3/4	0.830	1600	.750	19.04
7/8	1.000	1800	.875	22.22
1	1.200	2100	1.000	25.40
1-1/4	1.800	2400	1.250	31.70
APPROXIMATE SETTINGS FOR THRU-DECK WELDING				
3/4	.800 - 1.4	16-1900	.750	19.04
7/8	1.0 - 1.6	18-2200	.875	22.22

TW6922 Welding

Stud Welding - Step by Step

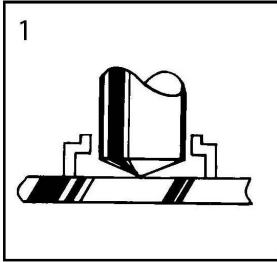

1 The weld gun is positioned over the base material and the main gun spring is partially compressed. Hold gun perpendicular to work surface and hold ferrule firmly against the surface.

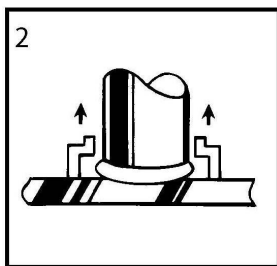

2 The trigger is pressed and the stud lifts off the base, drawing an arc. The arc melts the end of the weld stud and the base material below. The arc shield (ferrule) concentrates the heat below the weld stud and contains the molten metal within the weld zone. Do not move weld gun during weld.

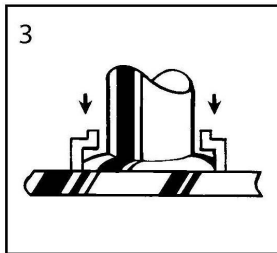

3 The main spring plunges the weld stud down into the molten pool of metal in the base material. The cycle is completed in less than a second and the resulting weld bond develops the full strength of the fastener in the weld zone. Allow metal to cool and withdraw gun from the stud, pulling the gun straight up off of the stud.

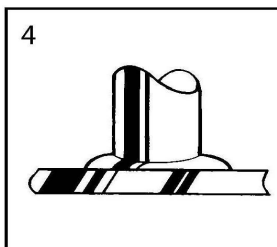

4 The weld gun is withdrawn from the weld stud leaving the weld and the ferrule. The ferrule is broken away and discarded. Visually inspect weld.

Note - when determining finished length required for the particular application, keep in mind the reduction in length (burn-off) from stud welding operations. TRU-WELD stud lengths are always given before weld.

Diameter of Stud	Reduction in Length
1/4" thru 1/2"	1/8"
5/8" thru 7/8"	3/16"
1" and over	1/4"

TW6922 Welding Hints and Suggestions

Stud Welding

- Keep weld studs and ferrules clean and dry
- Set the time for the appropriate weld base diameter (see chart on page 19)
- Set the amperage for the appropriate weld base diameter (see chart on page 19)
- Make sure the negative polarity is to the weld stud gun and ensure a good, clean ground connection
- Align accessories so they are centered and adjust legs so that 3/16" to 1/4" of the stud protrudes beyond the ferrule
- Make sure work surface is relatively clean so impurities do not affect weld
- Remove all coatings from weld areas
- Test the welds at the beginning of each shift or change in stud size. Bend two studs 30° after cooling (AWS Bend Test)
- Check burn off (1/8" – 3/16"), color (silver-blue and shiny), and weld fillet (360°).
- Visually inspect all welds

Thru-Deck Stud Welding

- Keep weld studs and ferrules clean and dry
- Never attempt thru-deck welding when the ambient temperature is below 32°F
- Deck must be layered flat on supporting members
- Deck must be properly grounded, be sure all cable connections are tight and secure
- Always use a thru-deck style ferrule
- Visually inspect all welds

To ensure satisfactory welds, bend test a minimum of one stud out of every one-hundred, by striking stud with a hammer and bending the stud 15° from its original axis

TW6922 Weld Inspection

Visual Weld Inspection and Adjustments - After shooting the stud, break away ferrule and visually inspect the weld.

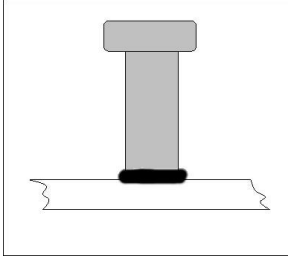

Good Weld

A good weld will have a smooth and even fillet with a blue-silver tint.

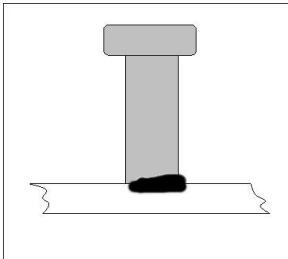

Partial Weld

A partial weld will result in a collar that does not extend around the entire diameter of the stud base. This outcome often occurs when the weld current is set too low.

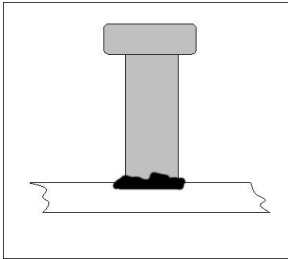

Irregular Weld

Irregular welds normally occur when the weld time is set too high and the fillet will be bumpy or jagged in appearance.

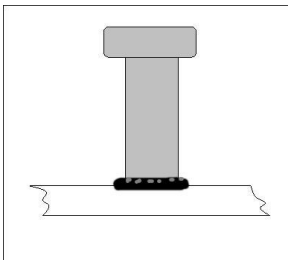

Porous Weld Collar

A porous weld fillet forms from the oxidation of the weld pool when the weld time is set too long and/or current is set too low.

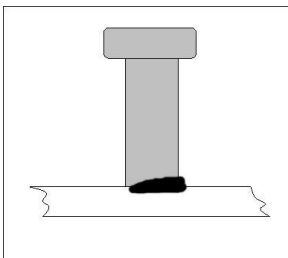

Weld Collar Off-Center

Off-center weld collars have a thick fillet on one half of the stud base and the stud may be tilted. Typically moving the or not having the gun perpendicular to the base material will result in an off-center collar.

TW6922 Troubleshooting

Problem	Possible Cause	Fix
Unit will not turn on	No power	<ol style="list-style-type: none"> 1. Test 3 phase power to control contactor 2. Check taps (if applicable) on main transformer 3. Check voltage selection plug near control transformer 4. Check fuse located on control transformer 5. Look for power available LED on control transformer 6. Make these checks before contacting a TWE Rep
Fan does not run when unit is turned on	This is normal	The fan will cycle on when the main bridge has reached nominal operating temperature. Ambient temperature of the weld site should also be taken in consideration.
Fan runs continuously (does not cycle on/off)	Thermostat circuit	A fault in the thermostatic circuit will cause the fan to run continuously, call a local TRU-WELD rep. for repairs
Unit turns on, coil boot test is good, no trigger from weld gun	Bad connection or faulty equipment	<ol style="list-style-type: none"> 1. Test control cable by plugging weld tool directly into unit (4 conductor straight through wiring) 2. Check gun trigger resistance (<100 ohms when closed) 3. Check to see if trigger LED on control panel responds 4. Check to see if weld tool is wired accordingly 5. Locate Touch/Trigger control board #16002, check and note the operation of the driver LED's and report the status
Unit turns on, no coil test, no lift from gun coil, trigger is good	Bad connection or faulty equipment	<ol style="list-style-type: none"> 1. Test control cable by plugging weld tool directly into unit (4 conductor straight through wiring) 2. Check 10 amp fuse on control board box next to breakers 3. Check hand tool coil resistance (12 - 40 ohms) 4. Locate Touch/Trigger Control Board TWE16158-1, check and note the operation of the driver LED's and report the status
Gun lifts, no weld arc drawn	Bad connection or faulty equipment	<ol style="list-style-type: none"> 1. Check connections for ground and weld tool leads 2. Check if contact LED on control panel lights when stud is touched to work surface (closing circuit) 3. Check the two circuit breakers on the control board box 4. Check to see if you have the sustaining arc (a small blue arc for the duration of the weld time) 5. Check to see if the stud sparks at the end of the weld cycle (hot plunge) 6. Locate Touch/Trigger Control Board TWE16158-1, check and note the operation of the driver LED's and report the status

TW6922 Troubleshooting

Problem	Possible Cause	Fix
Unit stops welding, overtemp LED is on	Over heating	<ol style="list-style-type: none"> 1. If the fan is running, allow unit to cool 2. Slow down welding rate (fewer studs per minute) 3. Any fault in the overtemp thermostat circuit will shut the system down
Weld output erratic or weak	Adjustments or settings	<ol style="list-style-type: none"> 1. Check welding hand tool set up, lift, plunge, and accessory adjustments 2. Check ALL weld current carry leads and connections, including grounds 3. Test the power loop by making welds on a test piece using only the starter cable set 4. Test 3 phase power to control contactor 5. Check taps (if applicable) on main transformer
Weld gun lifts, but does not plunge	Gun maintenance	If this happens, it is most likely binding inside of the gun. Perform routine gun maintenance or replace gun if needed

Note - Always turn off power to the welder before working on or testing components within the welder. Contact a TRU-WELD representative for replacement parts and for servicing welding equipment.

TW6922 Troubleshooting

Circuit board, control box, fuse, breaker and L.E.D. layout

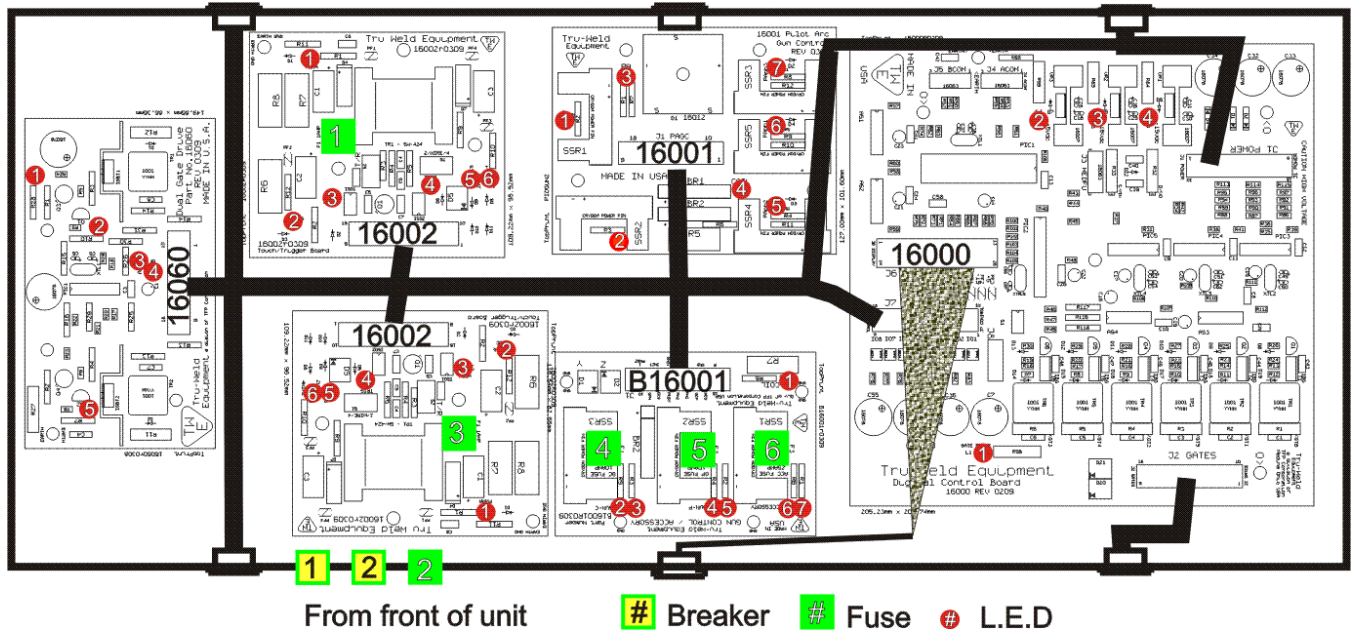

Board	16000	16001	16002	B16001	16060
Name	Digital Control	Pilot Arc Gun Control	Touch / Trigger	Gun Control Accessory	Dual Gate Drive
LED 1	L1- Gate Power	GPri - SSR1	L1 - PWRA - F1,3	LG4 - COIL	Yellow
	36 Volt Supply	Gun Primary	Touch Supply	YZ Output	+15 Vdc Supply
LED 2	L2- +5Vdc	GSec - SSR2	L6 - +5VDC	LG3 - GUN-C	RED - Q1
	Pos 5V Supply	Gun Secondary	Digital Supply	GLV Signal	TR1 Active
LED 3	L3- +15Vdc	LR6 - PA	L2 - WORK	LR3 - GUN-C	A - GREEN
	Pos 15V Supply	D1 Pilot Arc Output	Stud On Work Indicator	GC FUSE Indicator	Channel A Selected
LED 4	L4- -15Vdc	LR4 - COIL	L3 - TRIG	LG2 - GUN-P	B - GREEN
	Neg 15V Supply	BR1,2 Output	Trigger Indicator	GHV Signal	Channel B Selected
LED 5		LG1 - Paph2	L5 - 2WIRE	LR2 - GUN-P	RED Q2
		Drive Signal	Input #2 Supply	GP FUSE Indicator	TR2 Active
LED 6		LR5 - Paph1	L4 - 4WIRE	LG1 - ACCESS	
		Drive Signal	Input #1 Supply	ACC Signal	
LED 7		LR1 - Paph3		LR2 - ACCESS	
		Drive Signal		ACC FUSE Indicator	
FUSE		F2	F1,3	F4-6	
		AGC 10A 250V ¼ X 1¼ Hand Tool 1 Coil	1A 125V FST 5 X 20 mm LED 1 PWRA	10A 250V FST 5 X 20 mm Hand Tool 2 Coil	
BREAKER	BKR 1,2				

TW6922 Parts and Accessories

Closed Ferrule Grips (1" Long) Brass		Split Ferrule Grip (1" Long) Brass	
Stud Diameter	Part Number	Stud Diameter	Part Number
3/4"	GN-075	3/4"	GC-075
7/8"	GN-087	7/8"	GC-087
1"	GN-100	1"	GC-100
Adjustable Chucks		Headed Chucks	
Stud Diameter	Part Number	Stud Diameter	Part Number
3/4"	CN-075	5/8 & 3/4"	CH-075
7/8"	CN-087	7/8"	CH-087
1"	CN-100	1"	CH-100
Gun Legs		Thru-Deck Accessories	
Diameter & length	Part Number	Description	Part Number
5/16" x 7"	L-03107	Thru-Deck Foot Assembly	B-0021P or B-0021A
5/16" x 9"	L-03109	Foot Only	B-0021-1P or B-0021-1A
5/16" x 14"	L-03114	Extension Bar	B-0021-2
5/16" x 18"	L-03118	Screws	B-0021-3
3/8" x 7"	L-03707	Thru-Deck Ferrule Holder	Part Number
3/8" x 9"	L-03709	3/4" WTD/ 7/8" Flat	B-0060-1
3/8" x 14"	L-03714	3/4" Flat	B-0060-2
3/8" x 18"	L-03718	5/8" Flat	B-0060-3
3/8" x 24"	L-03724	1" Flat	B-0060-4
3/8" x 27"	L-03727	1/2" Flat	B-0060-5
3/8" x 32"	L-03732	Twin Leg Ferrule Foot Plates	
3/8" x 36"	L-03736	Diameter	Part Number
3/8" x 48"	L-03748	1/4"	QN-025
Gun Feet		5/16"	QN-031
1/4 - 1/2" Closed	B-1N	3/8"	QN-037
5/8 - 3/4" Closed	B-2N	1/2"	QN-050
7/8 - 1" Closed	B-3N	5/8"	QN-062
1/4 - 1/2" Split	B-1C	3/4"	QN-075
5/8 - 3/4" Split	B-2C	7/8"	QN-087
7/8 - 1" Split	B-3C	1"	QN-100



**TRU-WELD Stud Welding
Equipment Division**

6400 N. Honeytown Road

Smithville, Ohio 44677

(330) 725-7744 Phone

(330) 669-2473 Fax

TWE@tfpcorp.com

<http://truweldstudwelding.com>